

# F O C O S

Halógenos Baja Tensión 12v/50W

Halógenos Directos 50W/230v

Halógenos 300W/230v

Incandescentes

Delta MINICARRIL



Delta REGLETA 2 Focos  
430 mm.



Delta REGLETA 3 Focos  
660 mm.



Delta PLATILLO  
■ 120 mm.

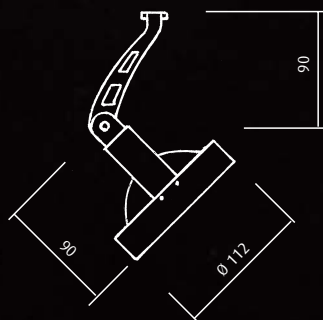

## Delta

### Acabados

- Níquel Mate
- Gris Metalizado
- Cromo Brillo
- Negro Mate
- Blanco

50 W

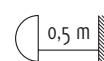

**Foco Bombilla Halógena  
Bajo Voltaje**

**QR 111 G53 12v IN230V**



INCLUIDA  
TRANSFORMADOR INCLUIDO

### Sena PLATILLO

■ 120 mm.



### Sena REGLETA 2 Focos

430 mm.



### Sena REGLETA 3 Focos

660 mm.



### Sena MINICARRIL

## Sena

### Acabados

- Níquel Mate
- Gris Metalizado
- Cromo Brillo
- Negro Mate
- Blanco

50W



**Foco Bombilla Halógena  
Bajo Voltaje  
QR 111 G53 12v IN230V**



INCLUIDA  
TRANSFORMADOR INCLUIDO

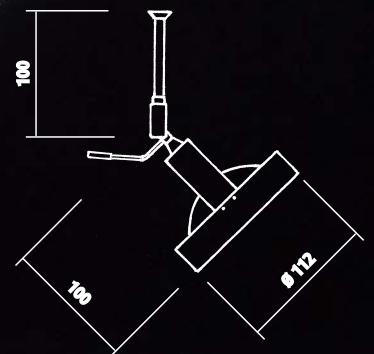

Nova MINICARRIL

## Nova

Foco halógeno  
baja tensión 50W/12V

### Acabados

- Níquel Mate
- Latón Brillo
- Cromo Brillo
- Gris Metalizado
- Blanco
- Negro

### Cristal

- Blanco

### Nova PLATILLO



### Nova PLAFON



#### PLAFON 2 Focos

Ø 220 mm  
Medidas brazos 13 cms  
Transformador Toroidal 100W

#### PLAFON 3 Focos

Ø 280 mm  
Medidas brazos 13, 15 y 40 cms  
Transformador Toroidal 150W

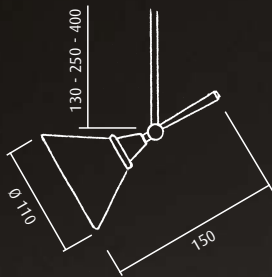

#### Convertidor Electrónico Incorporado

se suministra con brazo de 13, 25 ó 40 cms.



GY 6,35 Máx. 50W INCLUIDA  
IN-220/230V



### Nova REGLETA 2 Focos

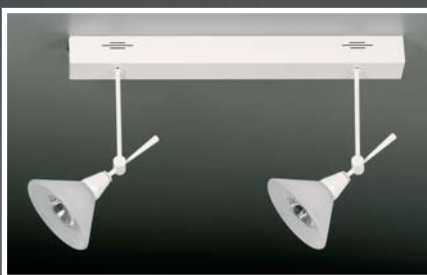

### Nova REGLETA 3 Focos

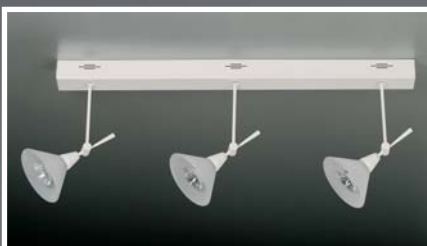

REGLETA 2 Focos 430 mm

REGLETA 3 Focos 660 mm

Medida brazo 13 cms

Transformador Convencional Clase I Incorporado

## Piccolo

Foco halógeno  
baja tensión 50W/12V

### Acabados

- Níquel Mate
- Latón Brillo
- Cromo Brillo
- Gris Metalizado
- Blanco
- Negro



Piccolo PLATILLO

### Piccolo PLAFON

#### PLAFON 2 Focos

Ø 220 mm  
Medidas brazos 13 cms  
Transformador Toroidal 100W



### Piccolo MINICARRIL



#### PLAFON 3 Focos

Ø 280 mm  
Medidas brazos 13, 15 y 40 cms  
Transformador Toroidal 150W



#### Convertidor Electrónico Incorporado

se suministra con brazo de 13, 25 ó 40 cms.



GY 6,35 Máx. 50W INCLUIDA  
IN-220/230V

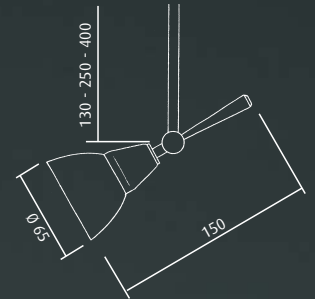

### Piccolo REGLETA 2 Focos

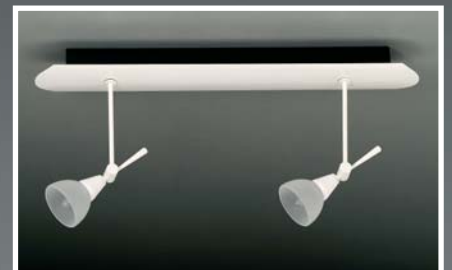

### Piccolo REGLETA 3 Focos

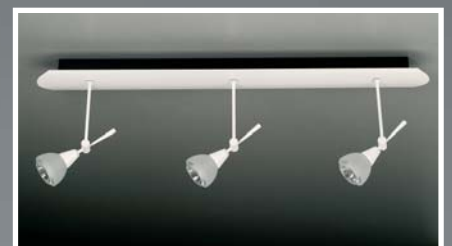

REGLETA 2 Focos 510 mm

REGLETA 3 Focos 740 mm

Medida brazo 13 cms

Transformador Convencional  
Clase I Incorporado

Geminis REGLETA 2 Focos



Geminis REGLETA 3 Focos



**REGLETA 2 Focos** 430 mm  
**REGLETA 3 Focos** 660 mm  
Medida brazo 130 mm  
Transformador Convencional  
Clase I Incorporado



**Geminis PLAFÓN 2 Focos**

Ø 220 mm  
Medidas brazos 13 cms  
Transformador Toroidal 100W

**Geminis PLAFÓN 3 Focos**

Ø 280 mm  
Medidas brazos 13, 25 y 40 cms  
Transformador Toroidal 150W

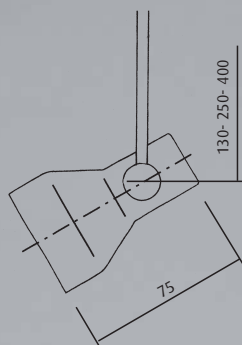

Geminis MINICARRIL



Geminis PLATILLO



**Convertidor Electrónico Incorporado**

se suministra con brazo de 13, 25 ó 40 cms.



**GY 6,35 Máx. 50W** INCLUIDA

**IN-220/230V**

**Ø 50 mm**



## Geminis

**Foco halógeno  
baja tensión 50W/12V**

### Acabados

- Níquel Mate
- Latón Brillo
- Cromo Brillo
- Gris Metalizado
- Blanco
- Negro

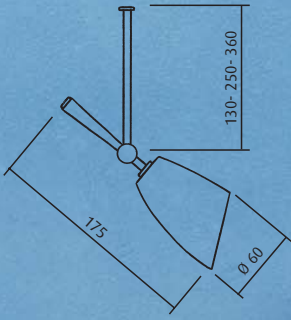

**Terra REGLETA**  
2 Focos 510 mm.  
3 Focos 740 mm.

Terra PLAFÓN 2 Focos

Terra PLAFÓN 3 Focos



**PLAFÓN 2 Focos**

Ø 220 mm

Medida brazo 13 cms

Transformador Toroidal 100W

**PLAFÓN 3 Focos**

Ø 280 mm

Medida brazo 13, 25 y 36 cms

Transformador Toroidal 150 W

## Terra

**Foco halógeno**  
**baja tensión 50W/12V**

### Acabados

- Níquel Mate
- Latón Brillo
- Cromo Brillo
- Gris Metalizado
- Blanco
- Negro

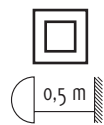

**Convertidor Electrónico Incorporado**

se suministra con brazo de 13, 25 ó 36 cms.

**GY 6,35 Máx. 50W** INCLUIDA

**IN-220/230V**

**Ø 50 mm**



Terra MINICARRIL



Terra PLATILLO





Challenger REGLETA 2 Focos



Challenger REGLETA 3 Focos



**REGLETA 2 Focos** 430 mm  
**REGLETA 3 Focos** 660 mm  
 Medida brazo 130 mm  
 Transformador Convencional  
 Clase I Incorporado

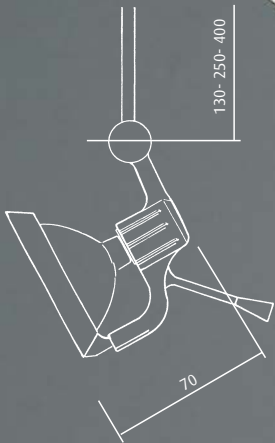

Challenger MINICARRIL Challenger PLATILLO



Challenger PLAFON

## Challenger

**Foco halógeno  
 baja tensión 50W/12V**

### Acabados

- Níquel Mate
- Latón Brillo
- Cromo Brillo
- Gris Metalizado
- Blanco
- Negro

### PLAFON 2 Focos

Ø 220 mm  
 Medidas brazos 13 cms  
 Transformador Toroidal 100W

### PLAFON 3 Focos

Ø 280 mm  
 Medidas brazos 13, 25 y 40 cms  
 Transformador Toroidal 150W

**Convertidor Electrónico Incorporado**  
 se suministra con brazo de 13, 25 ó 40 cms.

0,5 m **GY 6,35 Máx. 50W** INCLUIDA   
**IN-220/230V**  
**Ø 50 mm**



Mercury PLATILLO

Mercury MINICARRIL



Mercury REGLETA 2 Focos



Mercury REGLETA 3 Focos

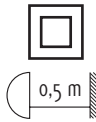

**Convertidor Electrónico Incorporado**  
se suministra con brazo de 13, 25 ó 40 cms.  
**GY 6,35 Máx. 50W**  
INCLUIDA  
**IN-220/230V**  
**Ø 50 mm**



Mercury PLAFÓN



**PLAFÓN 2 Focos**

Ø 220 mm  
Medidas brazos 13 cms  
Transformador Toroidal 100W

**PLAFÓN 3 Focos**

Ø 280 mm  
Medidas brazos 13, 25 y 40 cms  
Transformador Toroidal 150W

**REGLETA 2 Focos** 430 mm  
**REGLETA 3 Focos** 660 mm  
Medida brazo 130 mm  
Transformador Convencional Clase I Incorporado

**Mercury**

**Foco halógeno baja tensión 50W/12V**

**Acabados**

- Níquel Mate
- Latón Brillo
- Cromo Brillo
- Gris Metalizado
- Blanco
- Negro

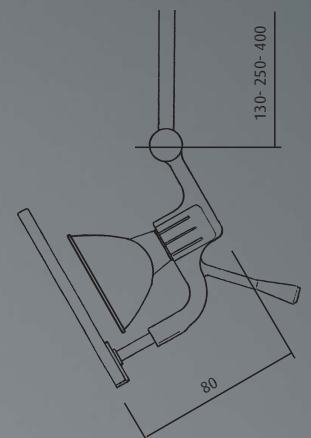
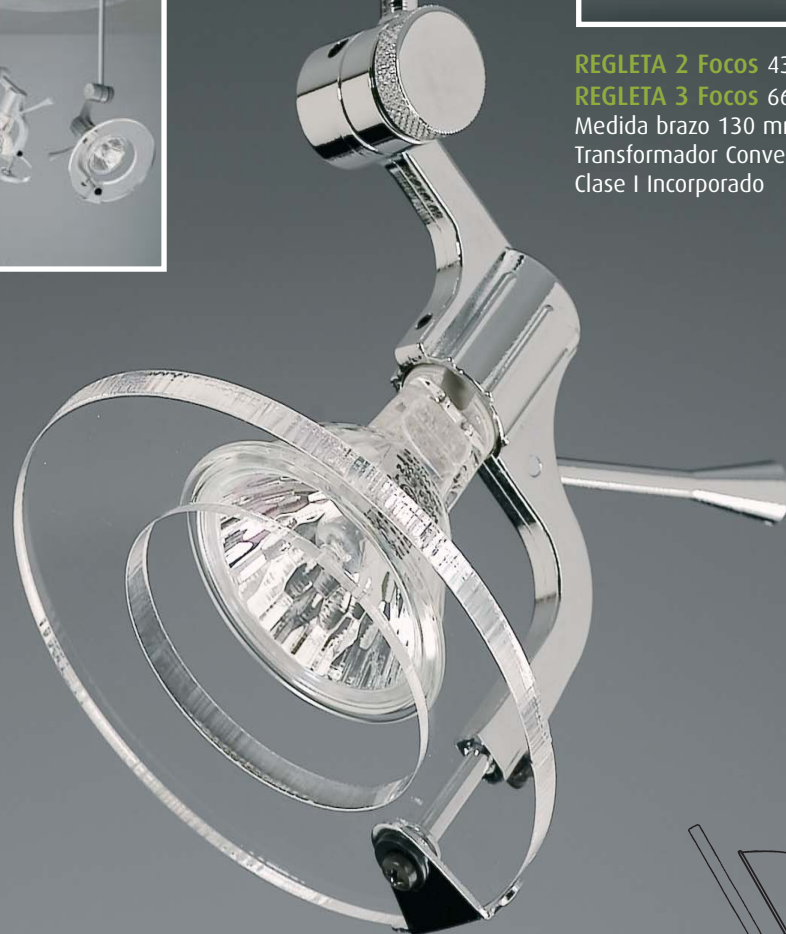



Radar PLATILLO

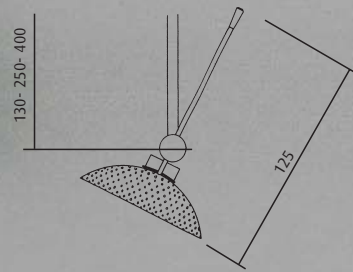

Radar MINICARRIL



Radar PLAFÓN



**Convertidor Electrónico**



**Incorporado**

se suministra con brazo de 13, 25 ó 40 cms.

**GY 6,35 Máx. 50W**



INCLUIDA

**IN-220/230V**  
**Ø 50 mm**

**PLAFON 2 Focos**

Ø 220 mm

Medidas brazos 13 cms

Transformador Toroidal 100W

**PLAFON 3 Focos**

Ø 280 mm

Medidas brazos 13, 25 y 40 cms

Transformador Toroidal 150W



Radar REGLETA 2 Focos



Radar REGLETA 3 Focos



REGLETA 2 Focos 430 mm

REGLETA 3 Focos 660 mm

Medida brazo 130 mm

Transformador Convencional  
Clase I Incorporado

**Radar**

**Foco halógeno  
baja tensión 50W/12V**

**Acabados**

- Níquel Mate
- Latón Brillo
- Cromo Brillo
- Gris Metalizado
- Blanco
- Negro

## Discovery

Foco halógeno  
baja tensión 50W/12V

### Acabados

- Níquel Mate
- Latón Brillo
- Cromo Brillo
- Gris Metalizado
- Blanco
- Negro

Discovery PLATILLO



Discovery MINICARRIL



**Convertidor  
Electrónico  
Incorporado**

0,5 m

se suministra con  
brazo de 13, 25 ó 40 cms.

**GY 6,35 Máx. 50W**



INCLUIDA

**IN-220/230V**

**Ø 50 mm**

Discovery PLAFÓN



### PLAFÓN 2 Focos

Ø 220 mm

Medidas brazos 13 cms

Transformador Toroidal 100W

### PLAFÓN 3 Focos

Ø 280 mm

Medidas brazos 13, 25 y 40 cms

Transformador Toroidal 150W

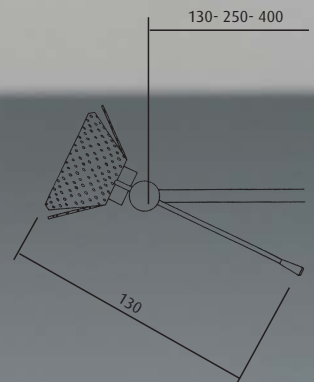

Discovery REGLETA 2 Focos

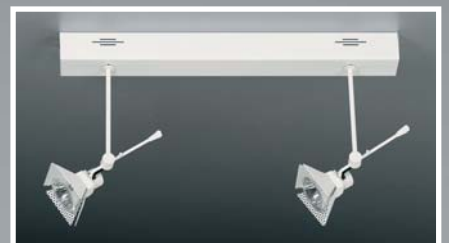

Discovery REGLETA 3 Focos

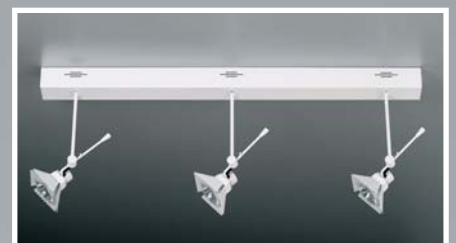

REGLETA 2 Focos 430 mm  
REGLETA 3 Focos 660 mm  
Medida brazo 13 mm  
Transformador Convencional  
Clase I Incorporado

## Libelula

Foco halógeno  
baja tensión 50W/12V

### Acabados

- Níquel Mate
- Latón Brillo
- Cromo Brillo
- Gris Metalizado
- Blanco
- Negro

### Libelula PLATILLO



#### Convertidor Electrónico Incorporado



se suministra con  
brazo de 13, 25 ó 40 cms.

**GY 6,35 Máx. 50W**



INCLUIDA

**IN-220/230V**

**Ø 50 mm**

### Libelula PLAFÓN



#### PLAFÓN 2 Focos

Ø 220 mm

Medidas brazos 13 cms

Transformador Toroidal 100W

#### PLAFÓN 3 Focos

Ø 280 mm

Medidas brazos 13, 25 y 40 cms

Transformador Toroidal 150W

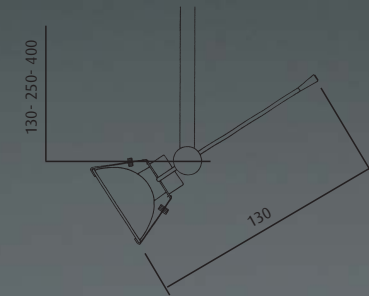

### Libelula REGLETA 2 Focos



### Libelula REGLETA 3 Focos

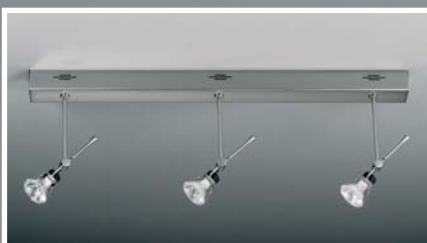

REGLETA 2 Focos 430 mm

REGLETA 3 Focos 660 mm

Medida brazo 130 mm

Transformador Convencional  
Clase I Incorporado

### Libelula MINICARRIL